

## General Series

General Series Valve Regulated Lead Acid batteries are designed with AGM (Absorbent Glass Mat) technology, high performance plates and electrolyte to gain extra power output for common power backup system applications widely used in the field of UPS, Emergency Lighting System.

## Application

- |                         |                        |
|-------------------------|------------------------|
| Alarm System            | Medical Equipment      |
| Cable Television        | UPS                    |
| Communication Equipment | Power tools            |
| Control Equipment       | Emergency Power System |
| Security System         | Toys                   |



## General Features

- Sealed and maintenance free operation.
- Non-Spillable construction design.
- ABS containers and covers(UL94HB, UL94V-0) optional.
- Safety valve installation for explosion proof.
- High quality and high reliability.
- Exceptional deep discharge recovery performance.
- Low self discharge characteristic.
- Flexibility design for multiple install positions.

## Construction

- |           |                   |              |                    |
|-----------|-------------------|--------------|--------------------|
| Component | .....Raw material | Sealant      | .....Epoxy Resin   |
| Positive  | .....Lead dioxide | Safety valve | .....EPDR          |
| Negative  | .....Lead         | Terminal     | .....Copper        |
| Container | .....ABS          | Separator    | .....Fiber glass   |
| Cover     | .....ABS          | Electrolyte  | .....Sulfuric acid |

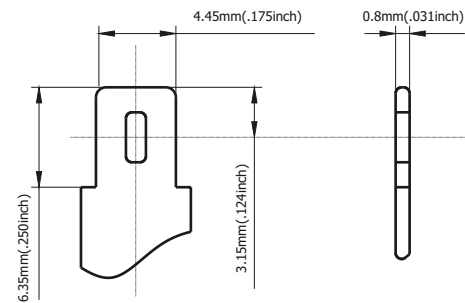

**Terminal Dimensions**

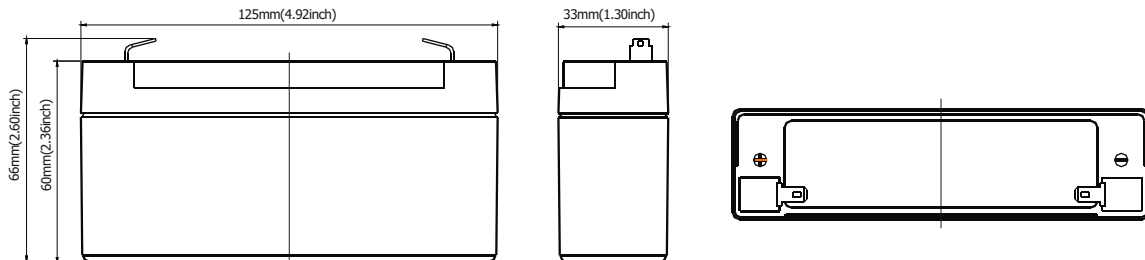

Battery Model	GB6-3.2			
Designed Floating Life	5 Years			
Capacity(25°C)	20HR(0.16A,1.75V)	10HR(0.3A,1.75V)	5HR(0.55A,1.75V)	1HR(2.10A,1.75V)
	3.2AH	3.0AH	2.75AH	2.1AH
Dimensions	Length	Width	Height	Total Height
	125mm(4.92inch)	33mm(1.30inch)	60mm(2.36inch)	66mm(2.60inch)
Approx. Weight	0.63Kg (1.39 lbs)			
Internal Resistance	Full charged at 25°C :0.024 Ohm			
Self Discharge	3% of capacity declined per month at (25°C)			
Capacity Affected by Temp.(20HR)	40°C	25°C	0°C	-15°C
	102%	100%	85%	65%
Charge Voltage(25°C)	Cycle use		Float use	
	7.2-7.5V(-15mV/ °C), max. Current: 0.96A		6.8-6.9V(-10mV/ °C)	

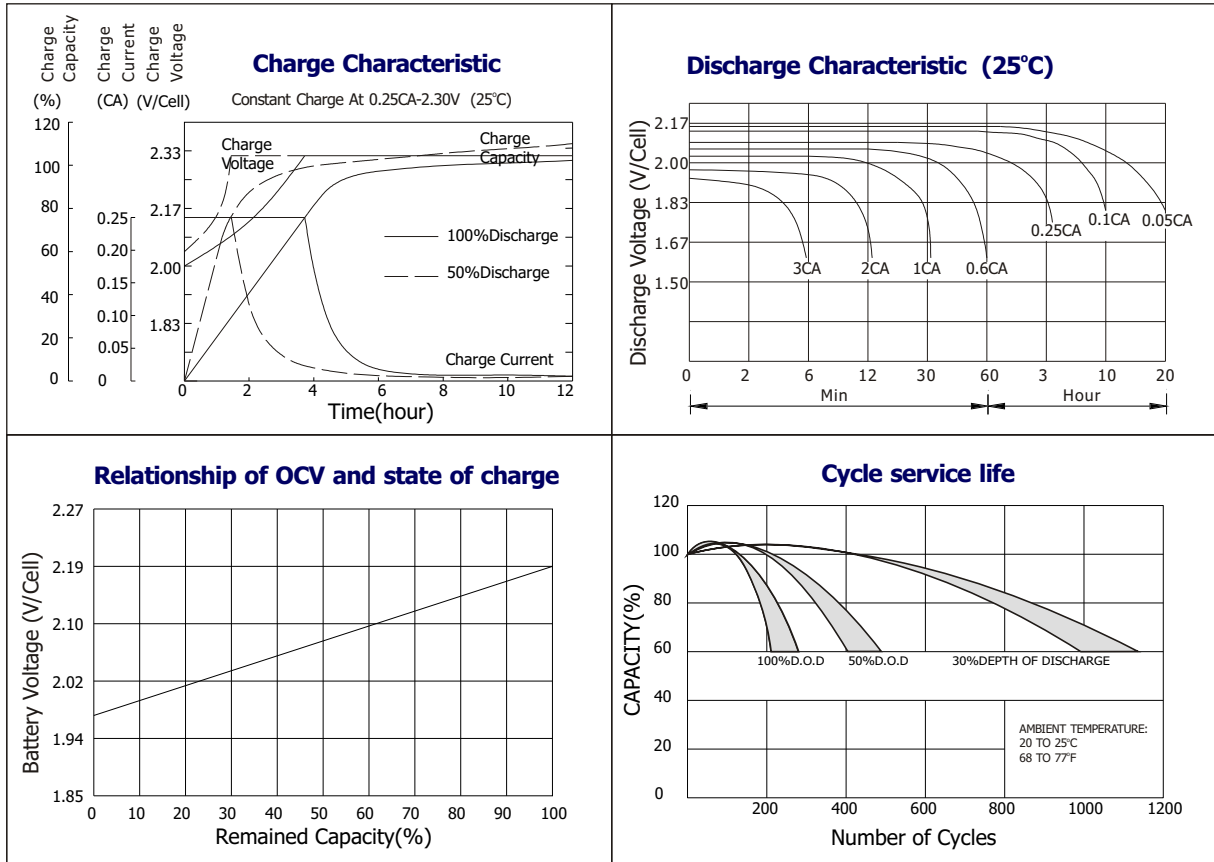

### Constant current discharge ratings-amperes at 25°C

F. V/Time	5MIN	10MIN	15MIN	30MIN	1HR	3HR	5HR	10HR	20HR
1.60V	12.5	7.78	5.87	3.58	2.27	1.00	0.61	0.34	0.18
1.67V	11.7	7.38	5.64	3.42	2.24	0.96	0.60	0.34	0.17
1.70V	10.8	7.11	5.51	3.11	2.18	0.90	0.58	0.34	0.17
1.75V	10.5	6.89	5.33	2.96	2.07	0.87	0.57	0.33	0.17
1.80V	9.43	6.58	4.84	2.74	1.94	0.83	0.54	0.33	0.16
1.85V	8.32	6.27	4.36	2.52	1.81	0.80	0.50	0.32	0.16

### Constant power discharge ratings-watts at 25°C

F. V/Time	5MIN	10MIN	15MIN	30MIN	1HR	3HR	5HR	10HR	20HR
1.60V	21.9	14.0	10.7	6.44	4.10	1.77	1.03	0.68	0.36
1.67V	21.2	13.7	10.6	6.31	4.08	1.72	1.03	0.68	0.35
1.70V	19.9	13.6	10.5	5.91	4.00	1.64	1.01	0.67	0.34
1.75V	20.1	13.5	10.4	5.73	3.93	1.60	1.00	0.67	0.33
1.80V	18.3	13.3	9.64	5.47	3.71	1.55	0.97	0.66	0.32
1.85V	16.6	12.6	8.75	5.12	3.49	1.51	0.94	0.62	0.31

